

1 2 3 4 5 6 7 8

F

E

D

C

B

A

F

E

D

C

DIE ON:YK238

SIZE: A4

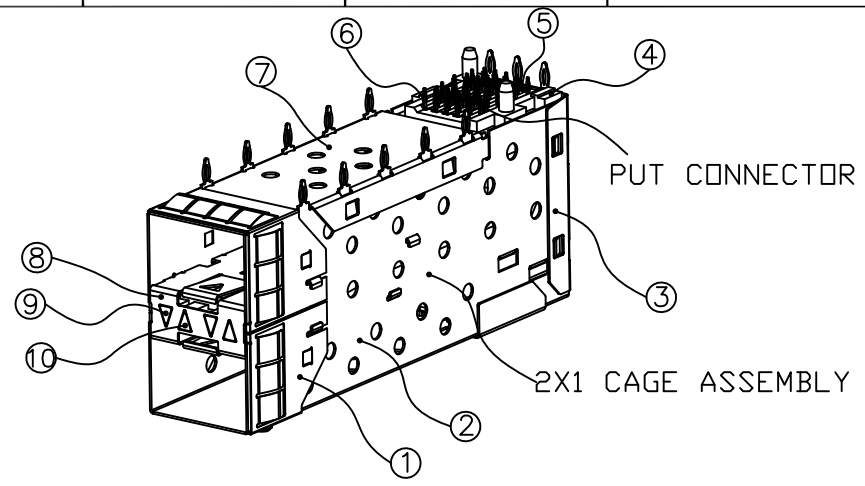
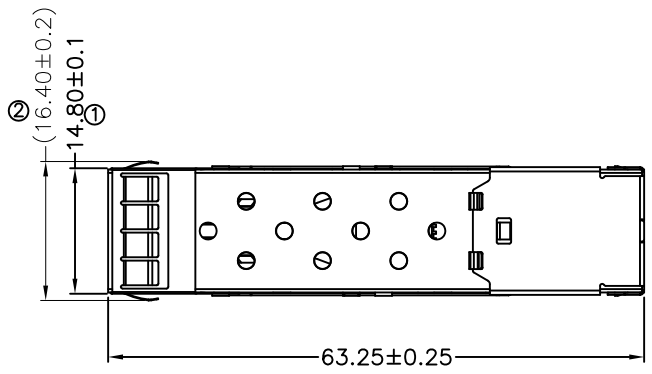

NOTES:  
 MECHANICAL REQUIREMENT:  
 1.DURABILITY:100CYCLES MIN  
 2.INSERTION ANDEXTRACTION FORCE :40N MAX&11.5N MIN  
 ENVIRONMENTAL:  
 1.TEMPERATIRE RANGE:-40°TO+85°C  
 2.STORAGE:-55°TO+105°C  
 3.PACKAGING:TRAY PACKAGING

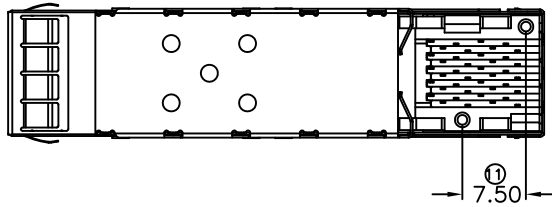
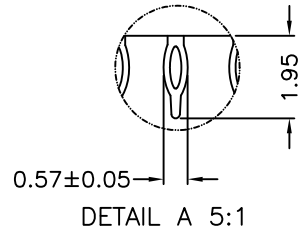
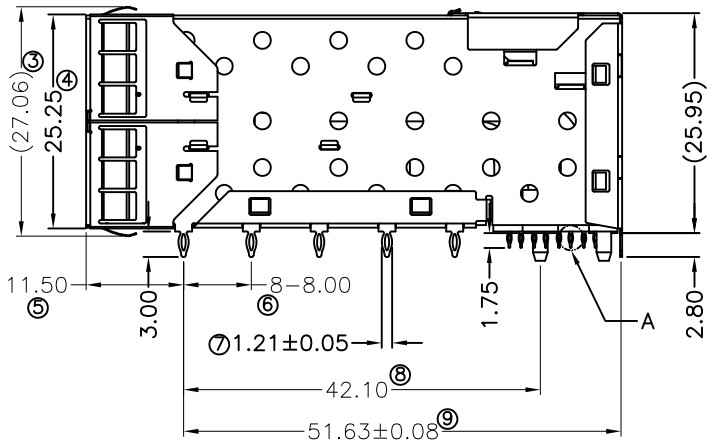
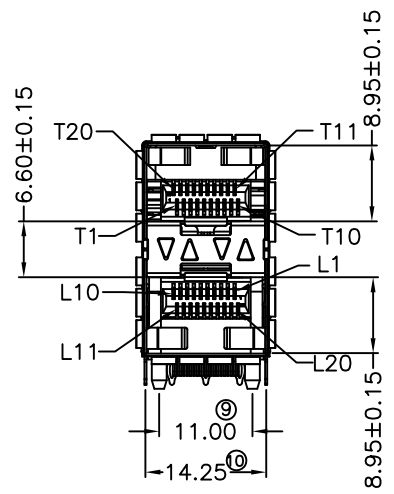

ITEM	PARTS NAME	Q'TY	MATERIAL	FINISH/REMARK
1	FRONT CAGE	1	SUS	
2	TOP CAGE	1	COPPER ALLOY	NI 50U" MIN
3	BACK CAGE	1	COPPER ALLOY	NI 50U" MIN
4	HOUSING	1	TEMPERATURE PLASTIC	BLACK
5	INSERT	10	TEMPERATURE PLASTIC	BLACK
6	TERMINAL	10	COPPER ALLOY	AU 15U" MIN
7	BOTTOM CAGE	1	SUS	
8	MID CAGE	1	COPPER ALLOY	NI 50U" MIN
9	LIGHT PIPES-01	1	POLYCARBONATE	TRANSPARENT
10	LIGHT PIPES-02	1	POLYCARBONATE	TRANSPARENT

REV.	ECN. NO.	DRAWN	DATE	EC.content
A.0	NEW	Liqiqing	12/05/2020	



⊗:QUALITY CONTROL ITEM APPROVED CHECKED DRAWN		GENERAL TOLERANCE .X± 0.13 X.*± 2' .XX± 0.08 .X*± 1' .XXX± 0.05	PART NO.: SFP21-2140-F210-01 TITLE:SFP+ 2X1 CAGE+CONNECTOR 15U"+LIGHT PIPE
UNIT: mm	SCALE: 1:1	SHEET: 1/3	REV.: A.0

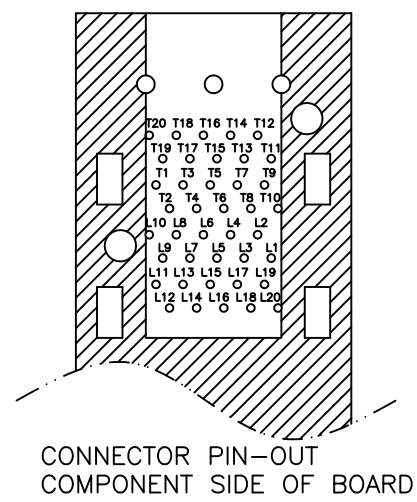
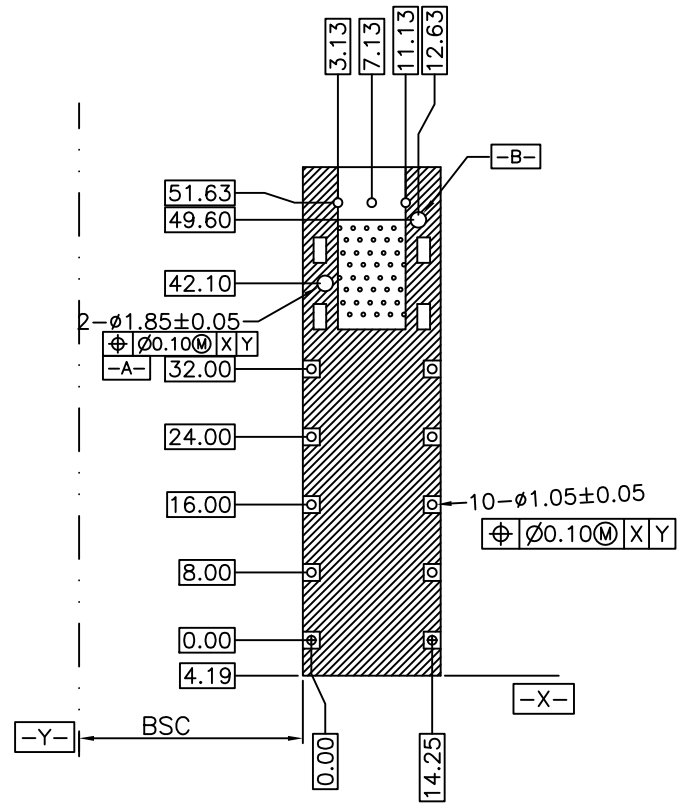

CONNECTOR PIN-OUT  
COMPONENT SIDE OF BOARD

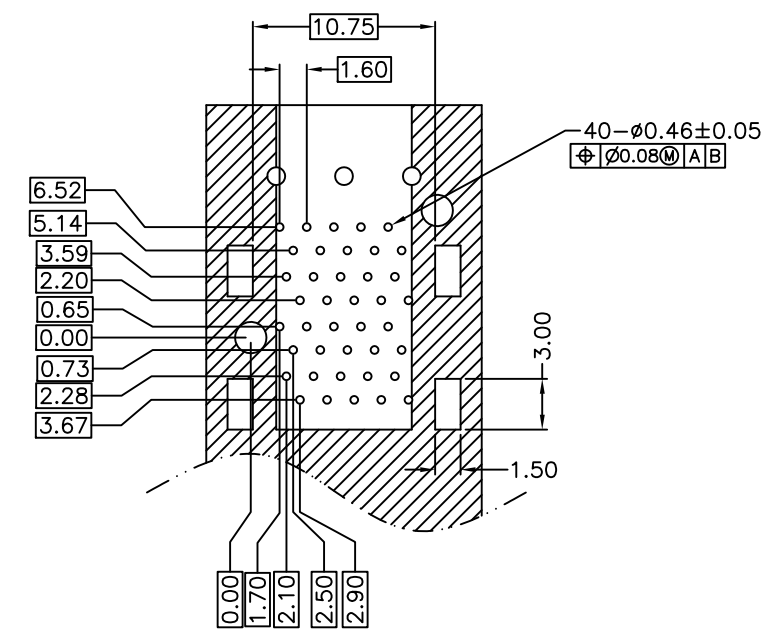

NOTES:  
1.DATUM AND BASIC DIMENSIONS ESTABLISHED BY CUSTOMSR.  
2.1.05mm DIAMETER HOLES ARE CHASSIS GROUND.

REV.	ECN. NO.	DRAWN	DATE	EC.content
A.0	NEW	Liqiqing	12/05/2020	



⊗:QUALITY CONTROL ITEM		GENERAL TOLERANCE		PART NO.: SFP21-2140-F210-01		
APPROVED		.X± 0.13	X.*± 2'	TITLE:SFP+ 2X1 CAGE+CONNECTOR 15U"+LIGHT PIPE		
CHECKED		.XX± 0.08	.X*± 1'			
DRAWN		.XXX± 0.05		UNIT: mm	SCALE: 1:1	SHEET: 2/3
						REV.: A.0

說明: △:備註 ◇:版本變更 (N):尺寸序號 ■:重點尺寸 ▼:CPK尺寸

DOCUMENT NO. : ZER0013/A.3

1 2 3 4 5 6 7 8

F

E

D

C

B

A

F

E

D

C

DIE ON:YK238

SIZE: A4

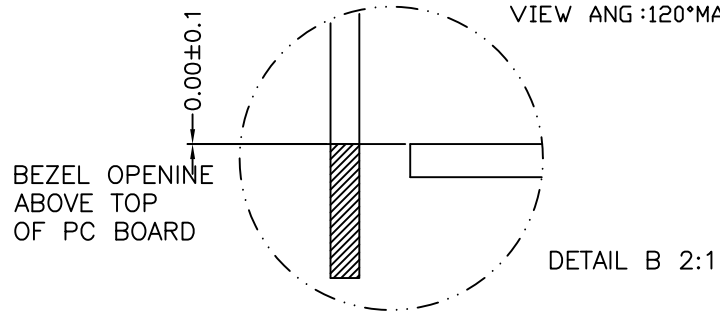
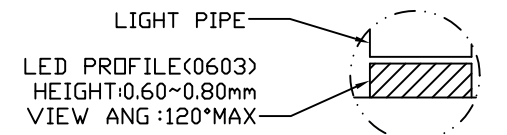
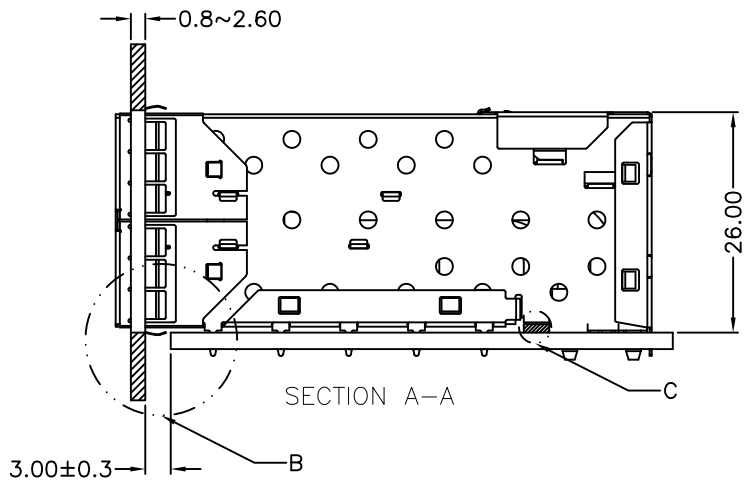
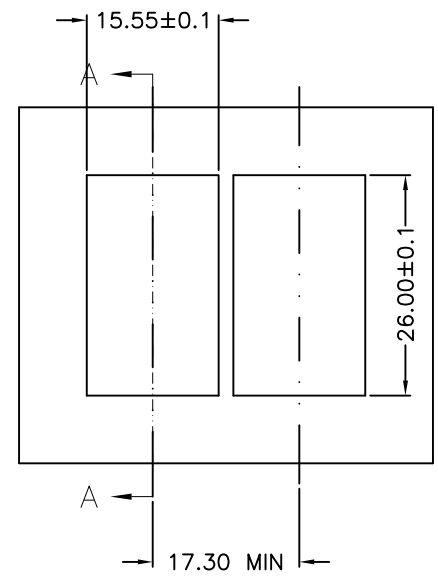
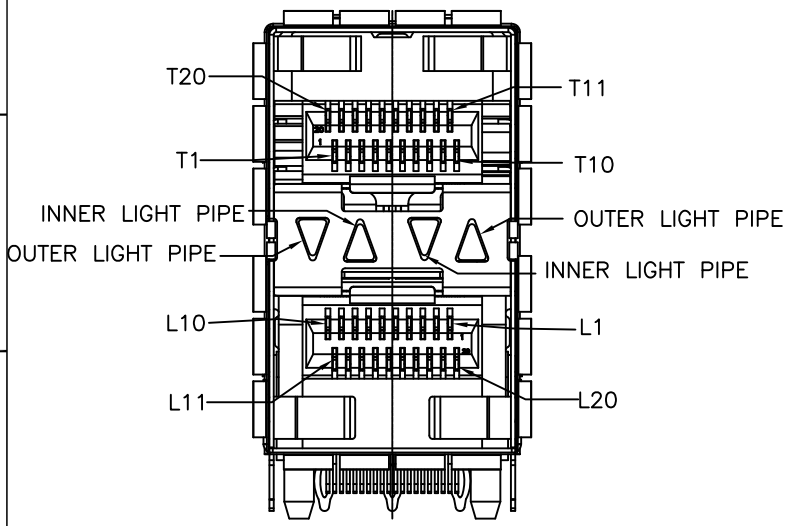

REV.	ECN. NO.	DRAWN	DATE	EC.content
A.0	NEW	Liqiqing	12/05/2020	



⊗:QUALITY CONTROL ITEM	GENERAL TOLERANCE .X± 0.13 X.*± 2' .XX± 0.08 .X*± 1' .XXX± 0.05	PART NO.: SFP21-2140-F210-01 TITLE:SFP+ 2X1 CAGE+CONNECTOR 15U"+LIGHT PIPE
APPROVED	UNIT: mm	SCALE: 1:1
CHECKED	SCALE: 1:1	SHEET: 3/3
DRAWN	SCALE: 1:1	REV.: A.0

說明: △:備註 ◇:版本變更 (N):尺寸序號 ■:重點尺寸 ▼:CPK尺寸

DOCUMENT NO. : ZER0013/A.3

1 2 3